

Slip Fit For
 "E" = 3/8" Dowel
 "M" = 10mm Dowel
 (2) Places

Drilled & C'bored For
 "E" = 1/2" SHCS
 "M" = M12 SHCS
 (4) Places

Ø 1.250in Ref.
 [31.75mm]

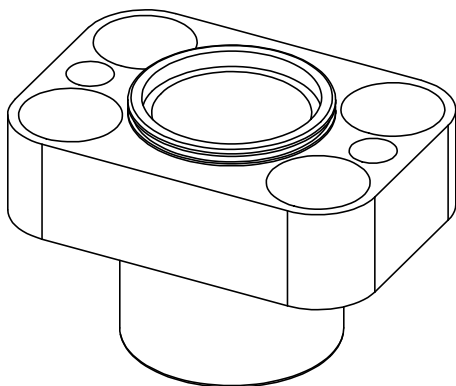
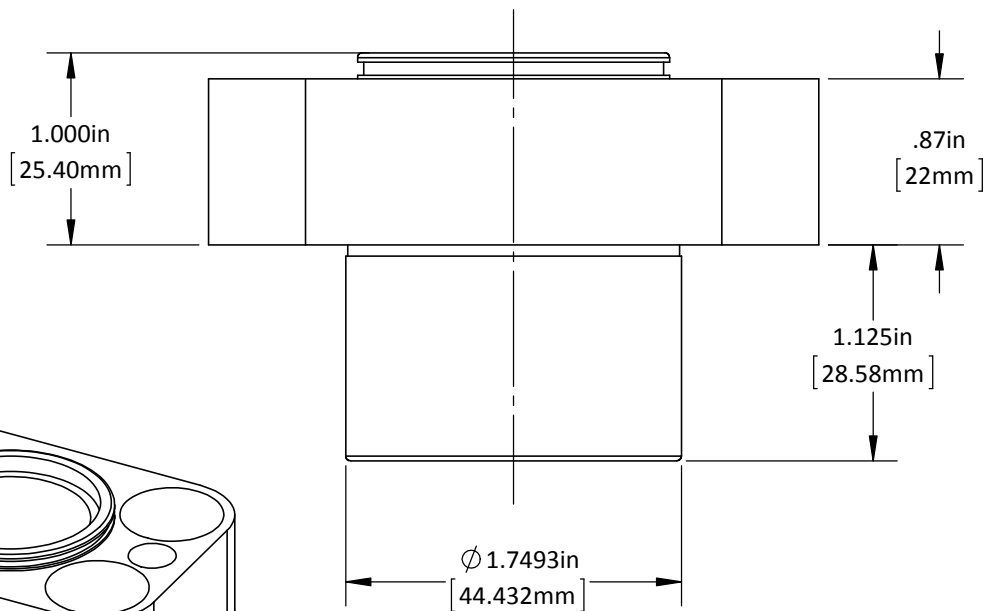

DO NOT SCALE DRAWING | REV 1
 This product may be covered by one or more patents or patent applications.
 See <http://www.standardlifters.com/patents.html> for details.

Base-GK120-D2
STANDARD LIFTERS INC

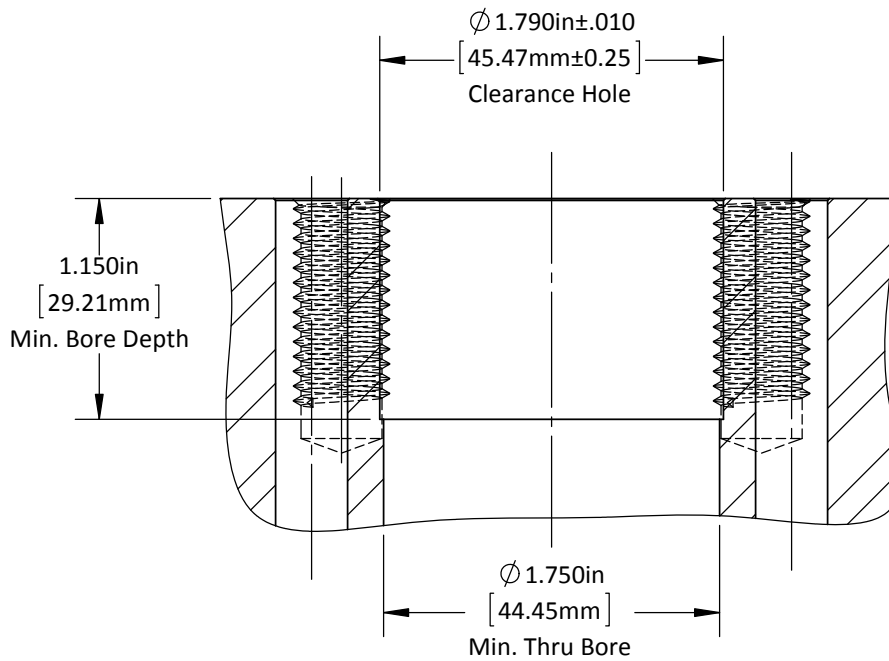
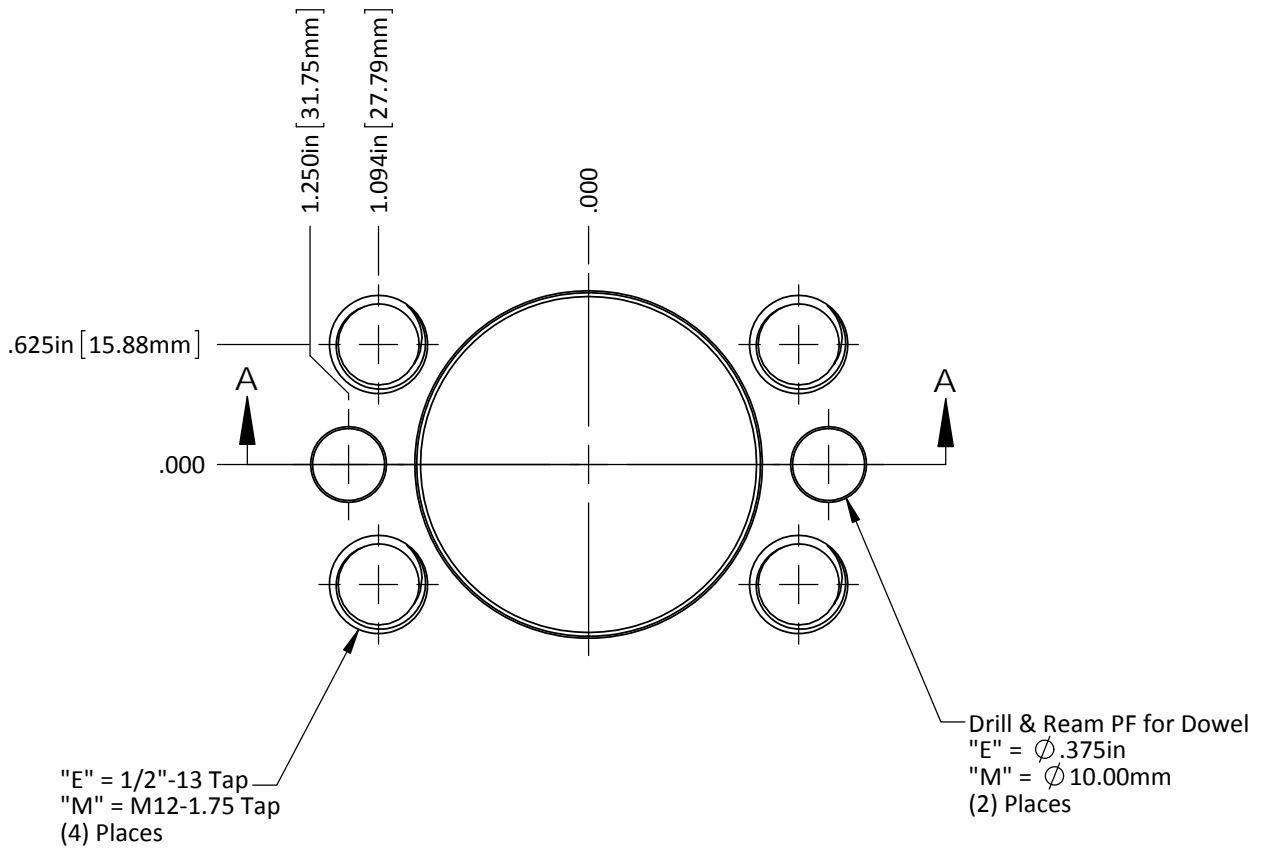

DO NOT SCALE DRAWING

REV 2

This product may be covered by one or more patents or patent applications.
See <http://www.standardlifters.com/patents.html> for details.

GK120-D2-Base Machining

STANDARD LIFTERS INC