

DO NOT SCALE DRAWING REV 1

This product may be covered by one or more patents or patent applications.
See <http://www.standardlifters.com/patents.html> for details.

Base-GK150-D3

STANDARD LIFTERS INC

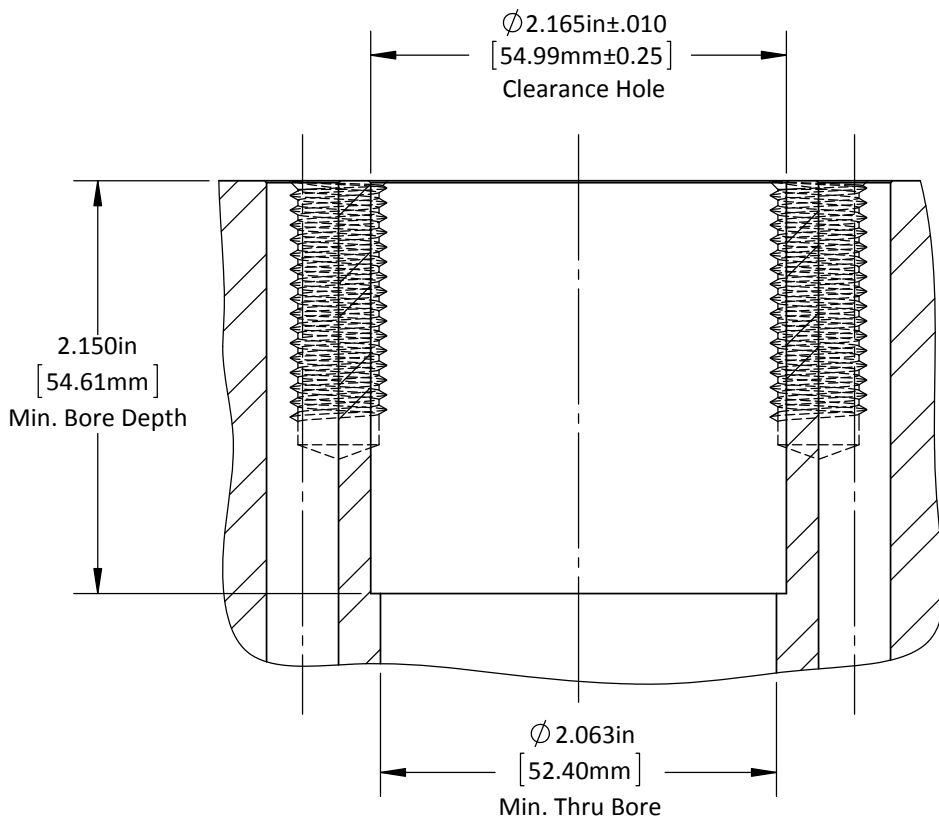
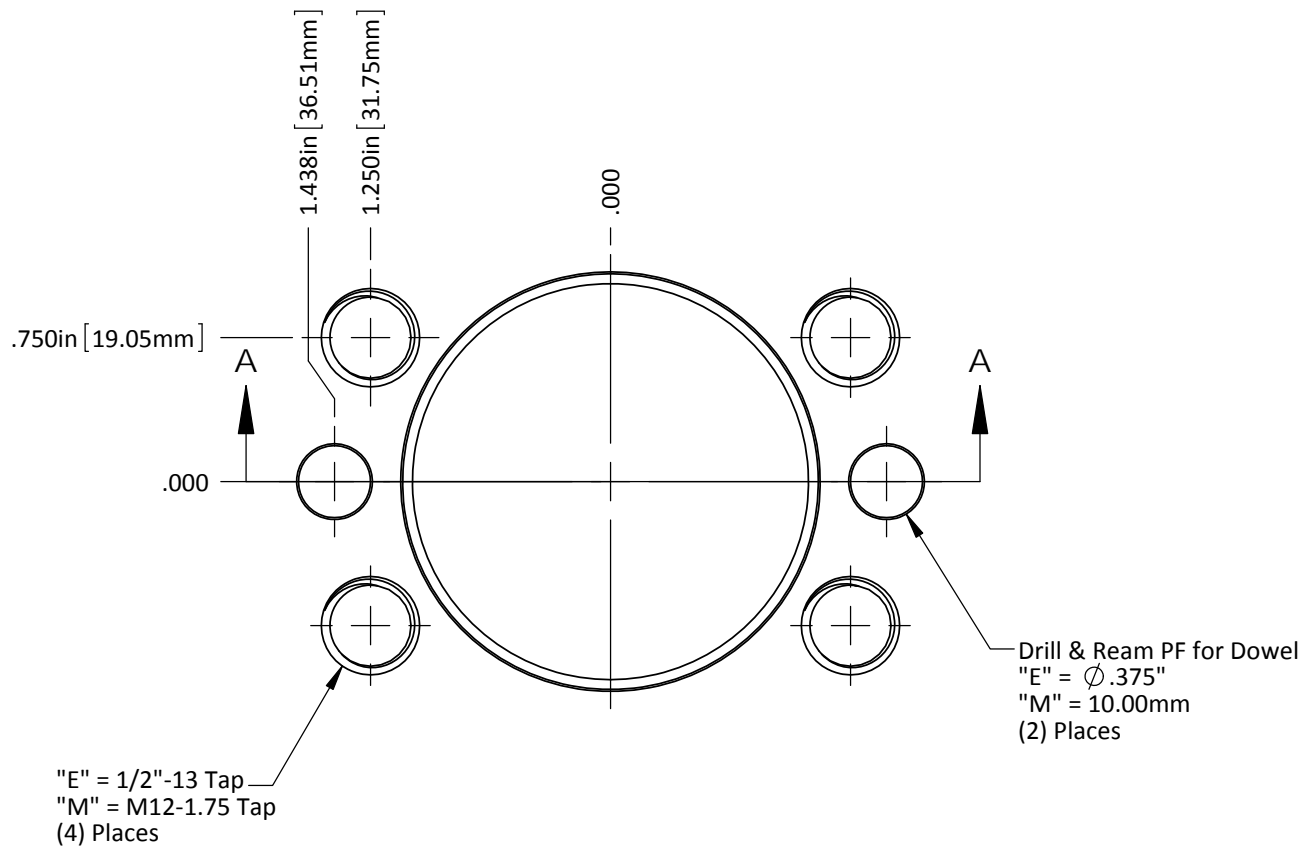

DO NOT SCALE DRAWING	REV 2
This product may be covered by one or more patents or patent applications. See http://www.standardlifters.com/patents.html for details.	

GK150-D3-Base Machining

STANDARD LIFTERS INC