

DO NOT SCALE DRAWING | REV 1

This product may be covered by one or more patents or patent applications.  
 See <http://www.standardlifters.com/patents.html> for details.

**Base-GK175-D2**

**STANDARD LIFTERS INC**

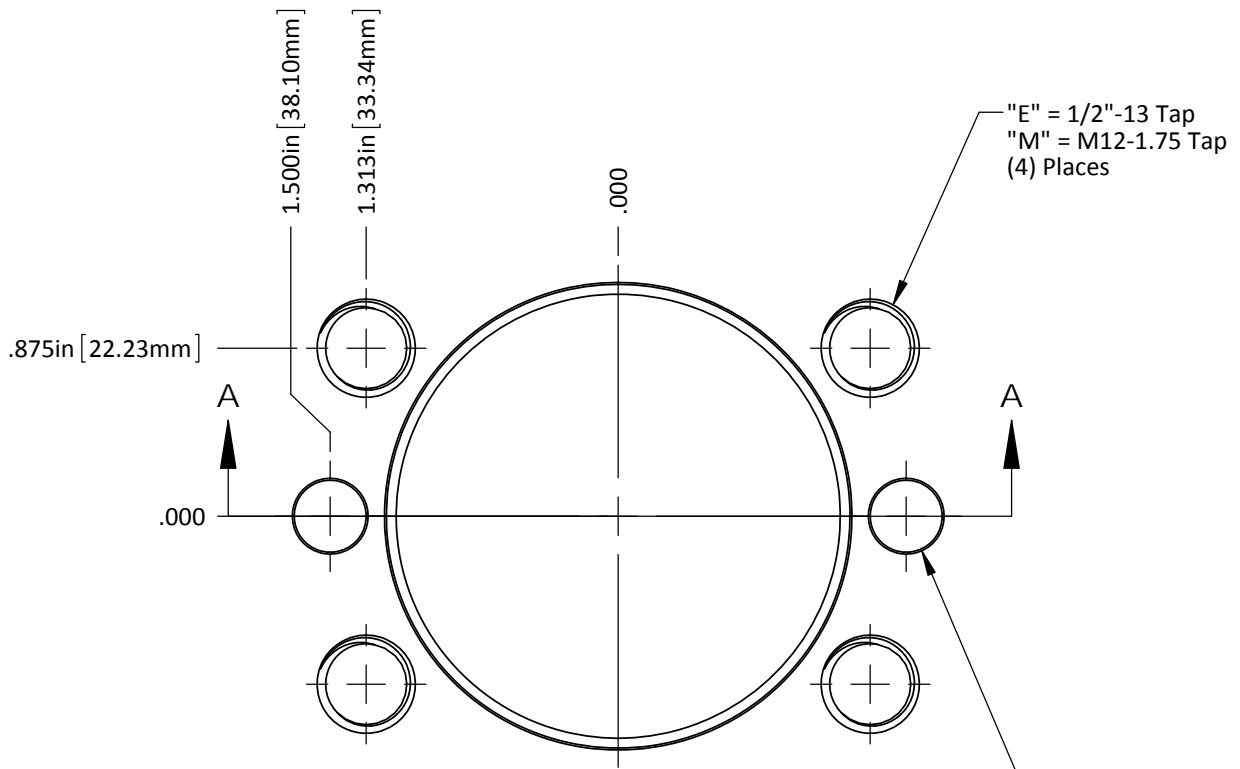

"E" = 1/2"-13 Tap  
 "M" = M12-1.75 Tap  
 (4) Places

Drill & Ream PF for Dowel  
 "E" =  $\varnothing .375\text{in}$   
 "M" =  $\varnothing 10.00\text{mm}$   
 (2) Places

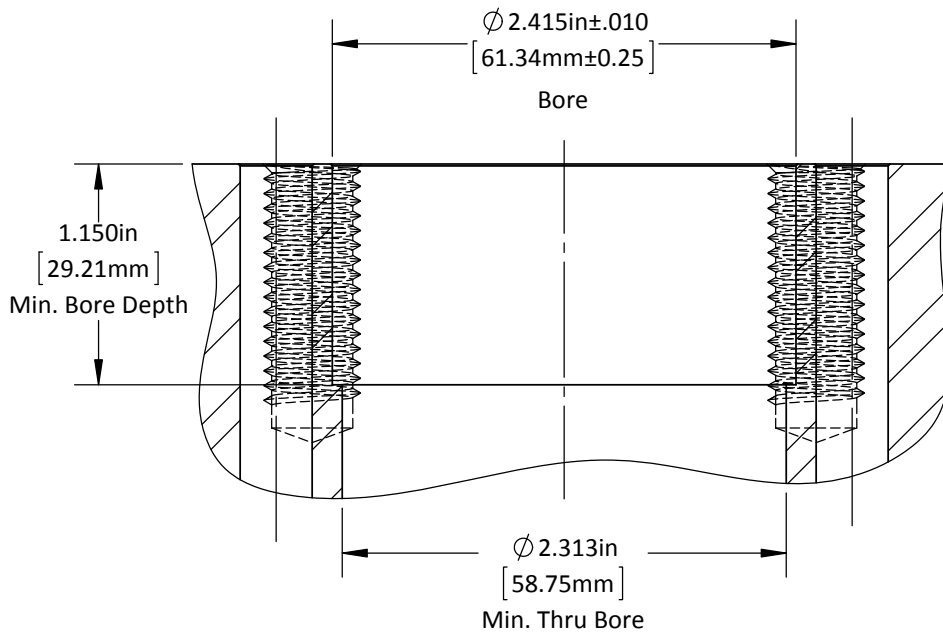

DO NOT SCALE DRAWING	REV 2
This product may be covered by one or more patents or patent applications. See <a href="http://www.standardlifters.com/patents.html">http://www.standardlifters.com/patents.html</a> for details.	

**GK175-D2-Base Machining**  
**STANDARD LIFTERS INC**