

**\*Caution: English & Metric Hole Locations are NOT the Same!**

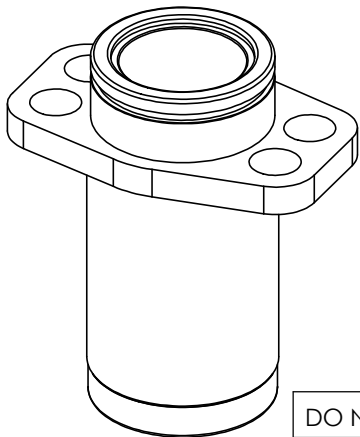
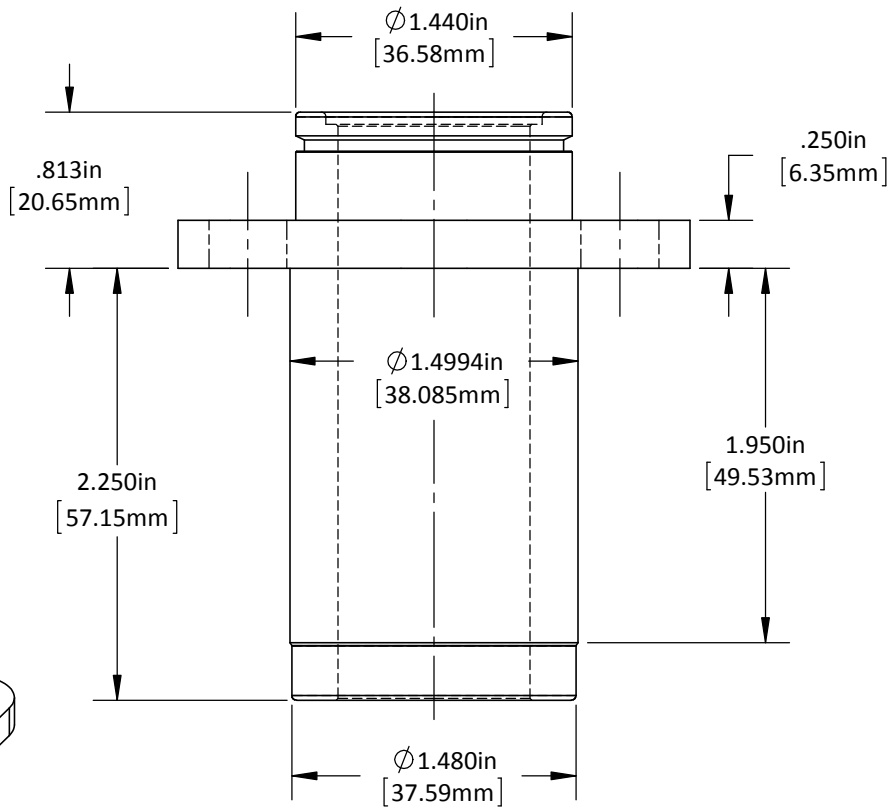
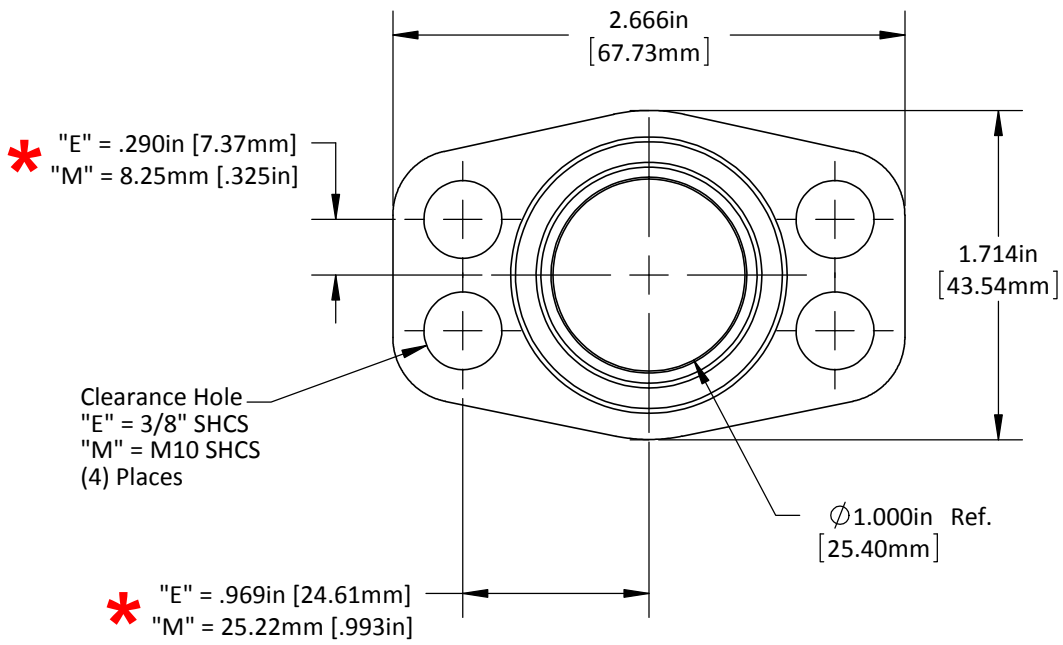

DO NOT SCALE DRAWING

REV 1

This product may be covered by one or more patents or patent applications. See <http://www.standardlifters.com/patents.html> for details.

**Base-GK95-L3**

**STANDARD LIFTERS INC**

**\*Caution: English & Metric Hole Locations are NOT the Same!**

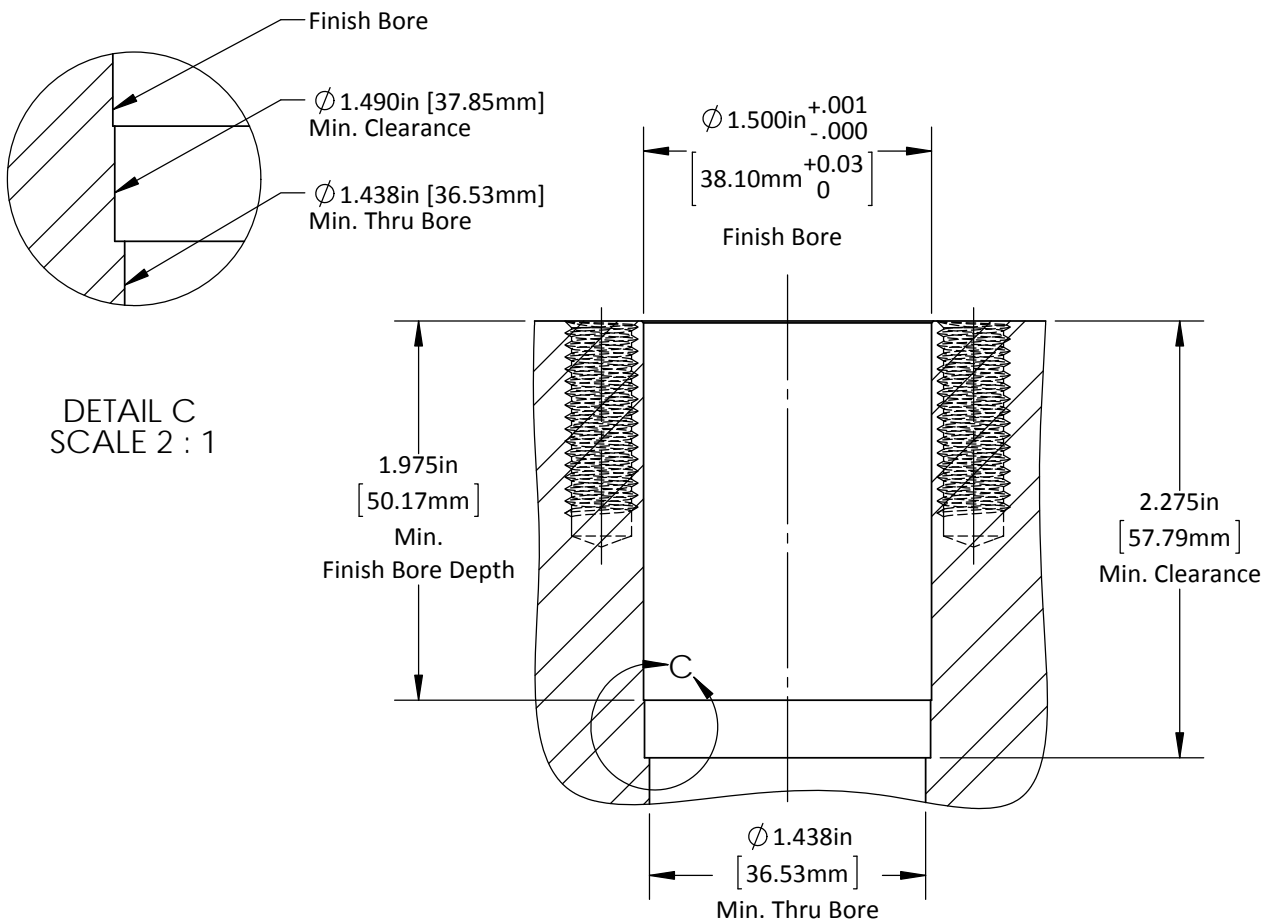
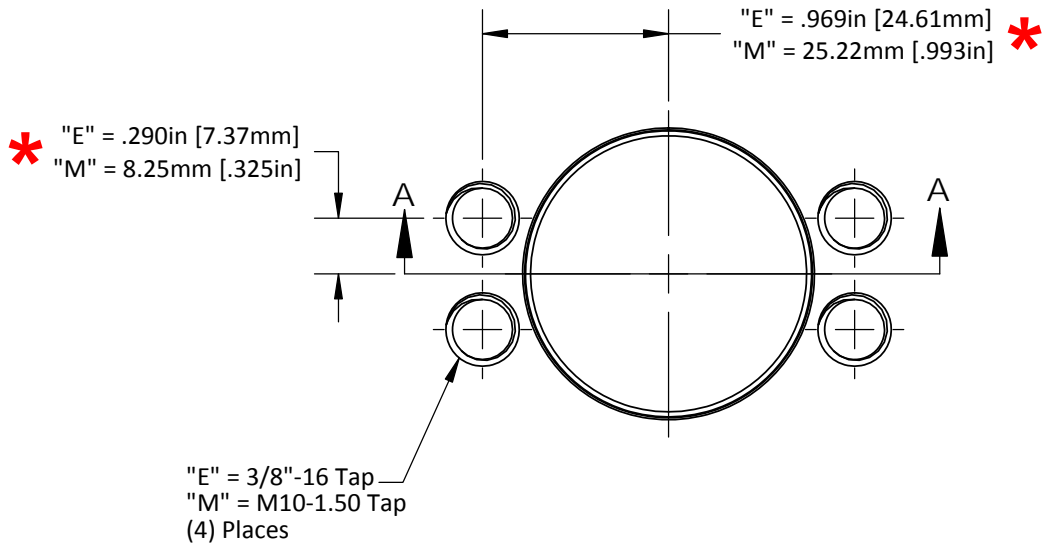

DO NOT SCALE DRAWING	REV 2
This product may be covered by one or more patents or patent applications. See <a href="http://www.standardlifters.com/patents.html">http://www.standardlifters.com/patents.html</a> for details.	

**GK95-L3-Base-Machining**  
**STANDARD LIFTERS INC**