

$\varnothing .094\text{in}$  [2.4mm] Ejector Pin  
 (6) Equally Spaced on a  
 $\varnothing .534\text{in}$  [13.56mm] Bolt Circle

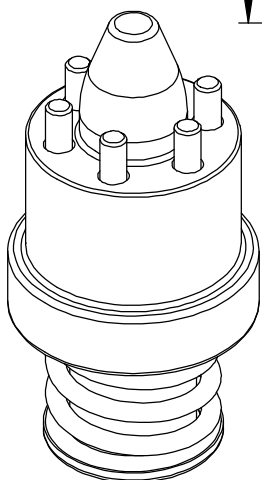
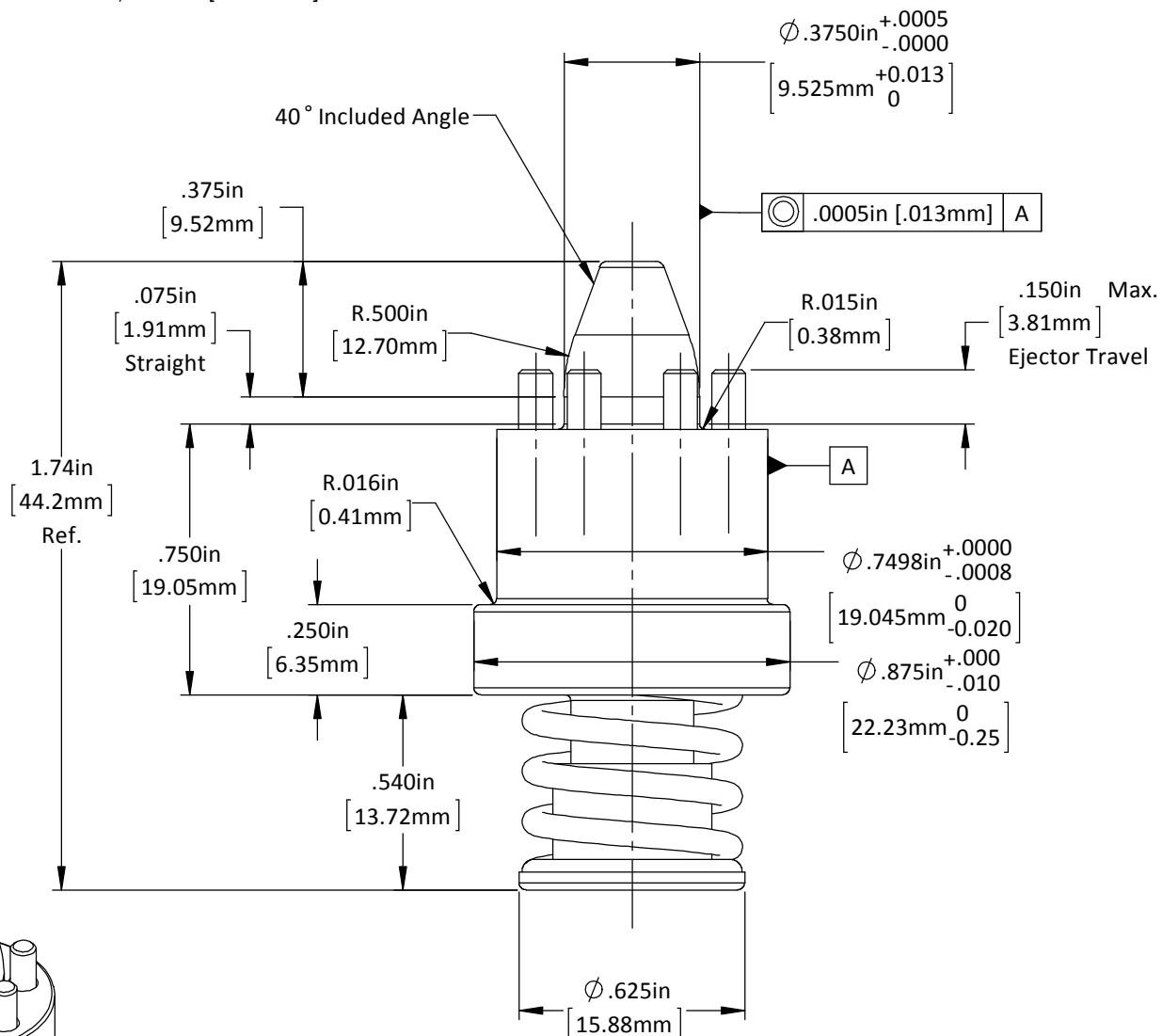

DO NOT SCALE DRAWING REV 2

This product may be covered by one or more patents or patent applications.  
 See <http://www.standardlifters.com/patents.html> for details.

**Pilot-PA-.375-.075-S-P-W**

STANDARD LIFTERS INC

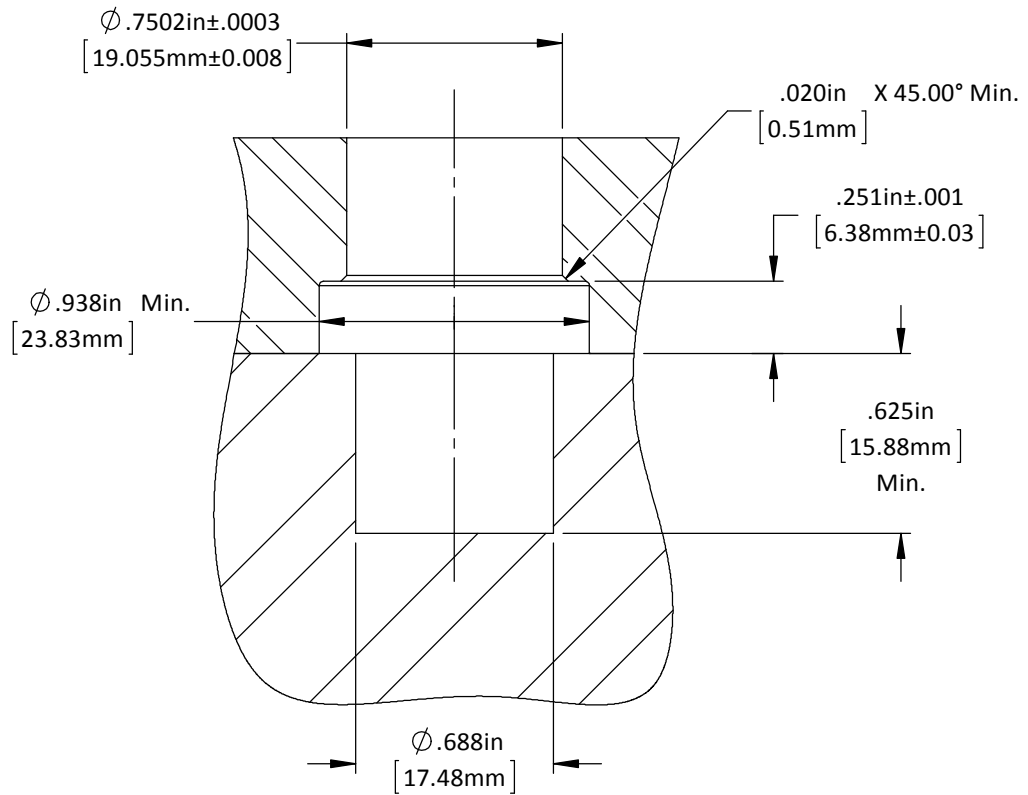
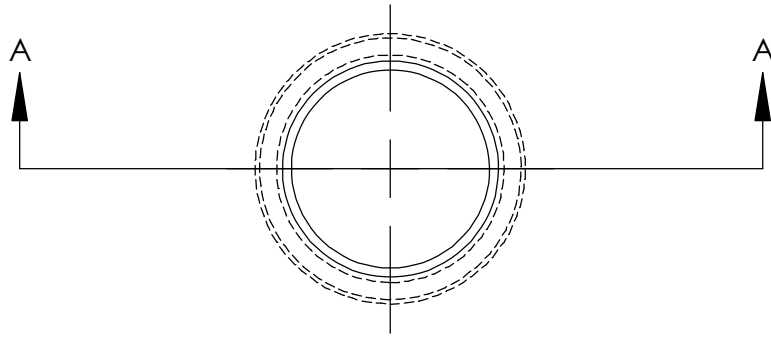

SECTION A-A

DO NOT SCALE DRAWING

REV 3

This product may be covered by one or more patents or patent applications.  
 See <http://www.standardlifters.com/patents.html> for details.

**Pilot-PA-.375-.075-S-P-W-Machining**

STANDARD LIFTERS INC